

Ray S HSG

Track Spot

Introducing track mounted spotlight that highlight the desired subject or place and provide optimum illumination by being nondescript.

The simplicity of its form provides smooth integration in architectural features.



Product Specs :

Model name :	Ray S HSG Track Spot
Weight:	0.5kg
Certificate Available:	Self Declaration Certificates
Colors Available:	Black / White
System Lumen:	1647 lm
System Wattage:	19 W
DC Current:	500 mA
Efficacy:	88 lm/W
CCT(K) :	3500K
CRI:	> 90
Bining:	≤3SDCM
Lifetime:	L80/B10 (>50,000hrs@Ta-30°C)
Beam Angle:	21°
IP Rating:	IP20
UGR:	<18
Efficiency:	>93%

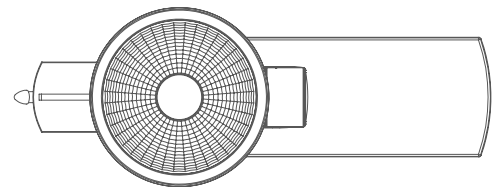
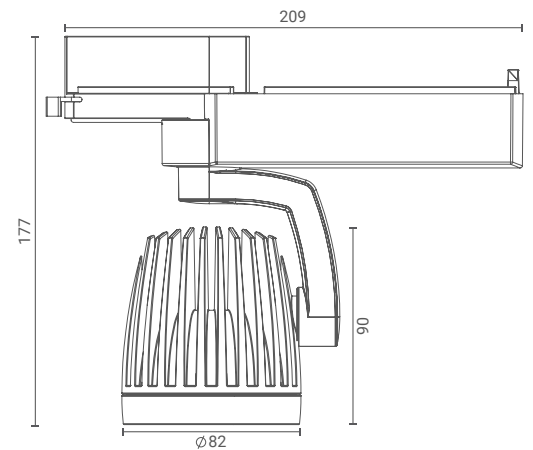

Driver Specs :

Input:	220-240V ~50/60Hz
Driver Type:	On-Off/ Dali2/DT8/AD/TD/BLE
THD:	<10%
Tunable & Dimmable:	Only Dimmable

